

Please read the instruction manual before installation.  
Please turn off the power supply before installation, operated by professional personnel.  
Once the ceiling is not strong enough, suggest to use self-made wooden frame for connecting. Avoid using wet cloth to clean the fitting.  
The light source of this product is not replaceable, when damaged or reached the service life should be replaced, and do a good job of recycling.  
Please do not assemble the product without authorization, any damage caused by disassembling without authorization will no longer be covered by the warranty.

Model	Input	Dimension(mm)	Cutout(mm)	Remark
81052828.2 81032528	AC 220V~240V	L56*W56*H76	60*60	
81032538 81012150	AC 220V~240V	L74*W74*H102	76*76	
81032110 81032128 81033238	AC 220V~240V	L99*W99*H125	102*102	
81033228 81052788 81032428	AC 220V~240V	L124*W124*H147	126*126	
81032078 81053210 81032648	AC 220V~240V	L149*W149*H173	151*151	

1

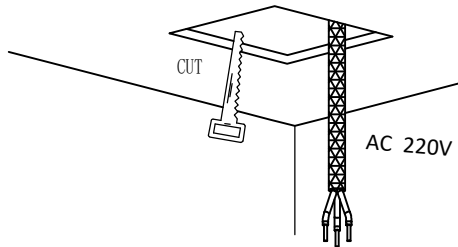

Open the mounting hole on ceiling according to the cutout size, and pass the wires through the hole.

2

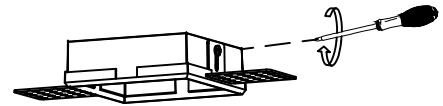

Adjust the bracket position according to thickness of ceiling.

3

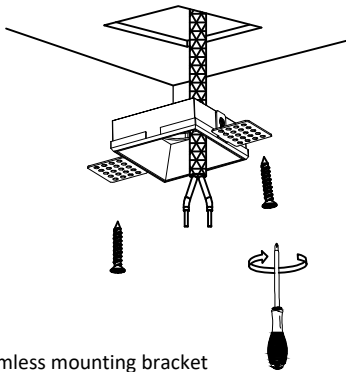

Clip the trimless mounting bracket into the cutout hole in the ceiling, then lock the trimless mounting bracket to the ceiling with self-tapping screws and pull the wire out of the bracket.

4

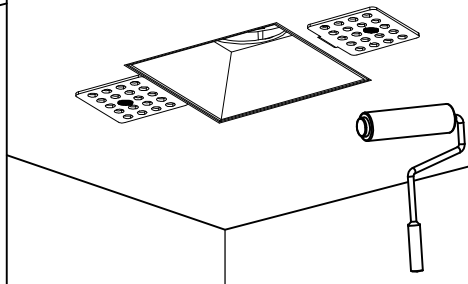

The trimless fixed bracket and joints shall be painted with plaster (it is recommended to paste mesh cloth before plaster to avoid wall cracking), and be covered with smooth and clean.

5

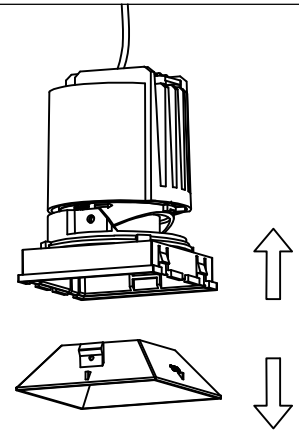

Take the reflector off from housing.

6

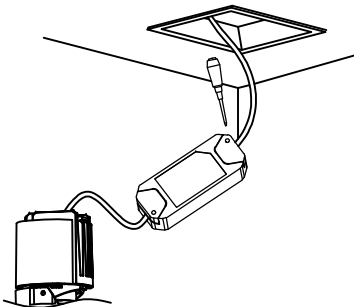

Remove the protective cover of the power supply with a screwdriver, connect the power cord according to the wiring instruction marked on the driver, and do the insulation protection well. And insert the driver into cutout on the ceiling.

2 Terminal block wiring

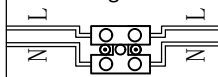

7

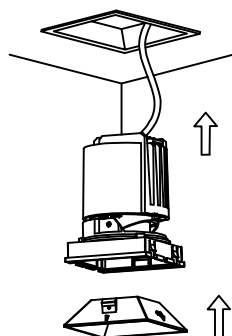

Install the housing on the trimless bracket and make sure it stable, then fix with reflector. Adjustable downlight series can adjust the irradiation angle according to the demand to meet the lighting requirements.

8

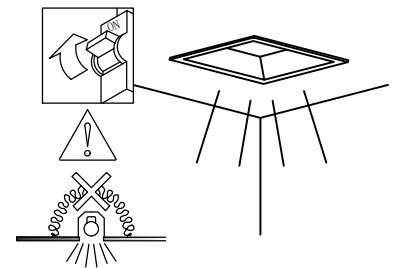

Turn on the power supply, lights up

Warning: The fitting should be never covered by insulation gasket or similar materials under any circumstance. Please ensure that the wires are connected correctly before turning on the power supply. Do not look emitting lights directly to avoid burning your eyes.