

Please read the instruction manual before installation.
Please turn off the power supply before installation, operated by professional personnel.
Once the ceiling is not strong enough, suggest to use self-made wooden frame for connecting. Avoid using wet cloth to clean the fitting.
The light source of this product is not replaceable, when damaged or reached the service life should be replaced, and do a good job of recycling.
Please do not assemble the product without authorization, any damage caused by disassembling without authorization will no longer be covered by the warranty.

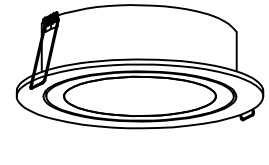

Model	Input	Dimension(mm)	Cutout(mm)	Remark
81018278	AC 220V~240V	∅50*H27	∅45	
81052968	AC 220V~240V	∅50*H20	∅44	
81052998	AC 220V~240V	∅58*H20	∅50	

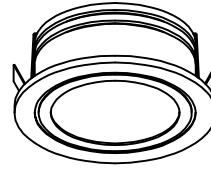
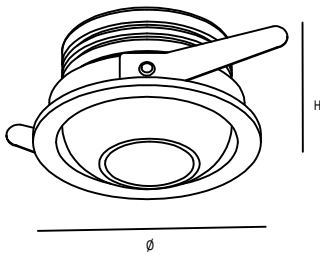

1

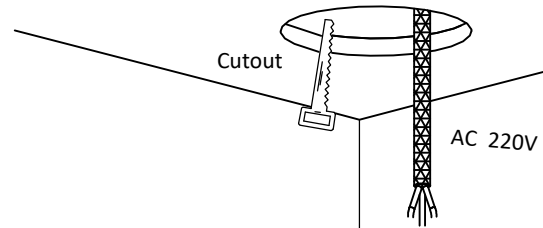

Open the mounting hole on ceiling according to the cutout size, and pass the wires through the hole.

2

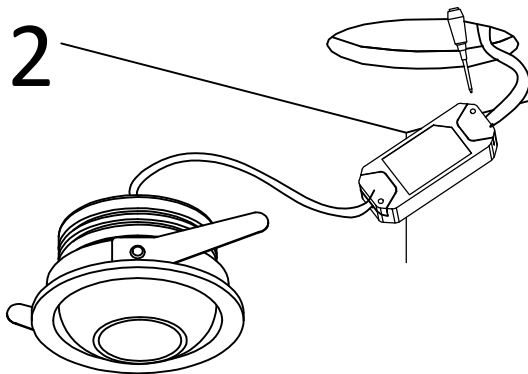

Remove the protective cover of the power supply with a screwdriver, connect the power cord according to the wiring instruction marked on the driver, and do the insulation protection well. And insert the driver into cutout on the ceiling.

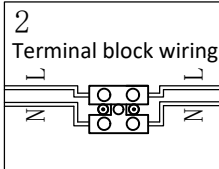

3

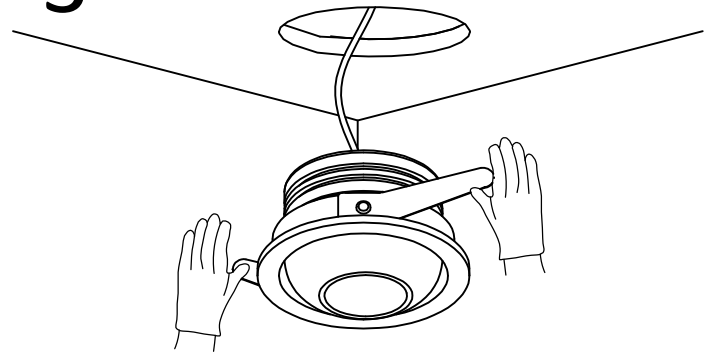

Press the mounting spring into the cutout in the ceiling and push the luminaire in.

4

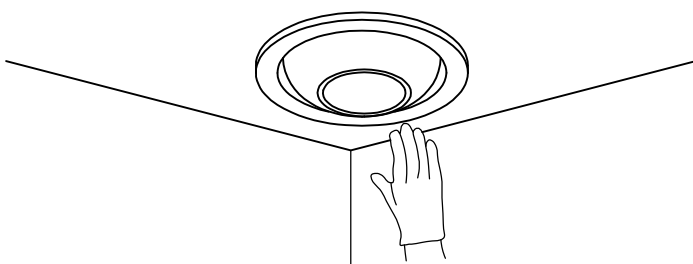

The installation is completed until the frame is flat with the ceiling.
Adjustable downlight series can adjust the irradiation angle according to the demand to meet the lighting requirements.

5

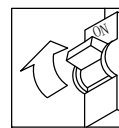

Turn on the power supply, lights up.

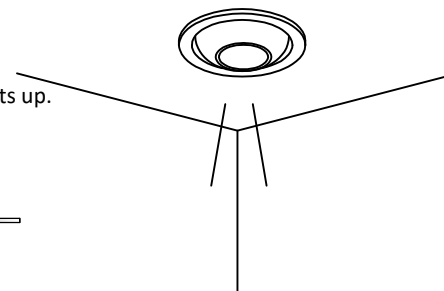
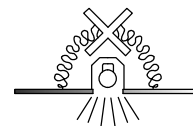

Warning: The fitting should be never covered by insulation gasket or similar materials under any circumstance.
Please ensure that the wires are connected correctly before turning on the power supply. Do not look emitting lights directly to avoid burning your eyes.